



PAIRUI

Http: fuantronics.com

P3 **T3.94*1.78*1.78** **HP**
Material **Core Size** **Coating**
 材质 品名 涂装

HP: Parylene Coating of Ja; pgem-Free

Ferrite core

Dimensions: (UNIT:mm)

Dimensions(mm)			Wt(g/set)
Parylene Coating Dimensions(mm)			
ΦD1	ΦD2	H	0.05
3.94±0.3	1.78±0.2	1.78±0.2	
3.94±0.3	1.78±0.2	1.78±0.2	

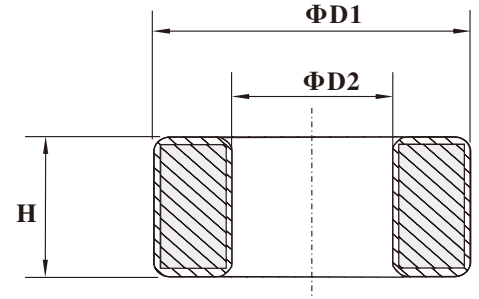
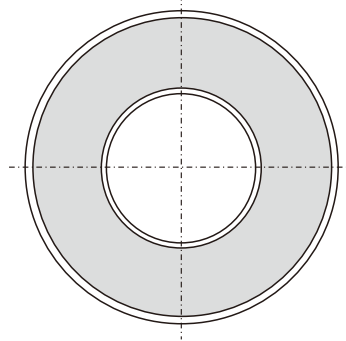

Test Conditions

AL: F=10.0KHz U=0.3V N=10Ts

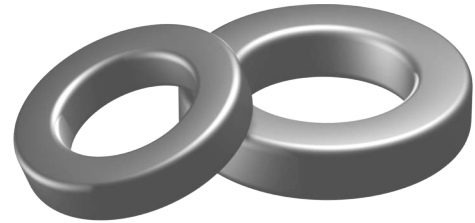

Effective parameter

	Ve(mm3)	Ae(mm2)	Le(mm)
	14.75	1.822	8.09

Coating

The core are coated with epoxy, flame retardant in accordance with "UL 94V-0" file number E228348. The colour is green.

Ring core data

GRADE	AL(nH)	μi	TYPE NUMBER
P3	680±25%	≈2300	T3.94/1.78/1.78/P3
H5K	1413±25%	≈5000	T3.94/1.78/1.78/H5K
H7K	2120±25%	≈7000	T3.94/1.78/1.78/H7K
H10K	2827±30%	≈10000	T3.94/1.78/1.78/H10K

Note:

- 1: Document is the property of FUAN Inc & is not allowed to be duplicated without authorization
- 2: RoHS compliant.

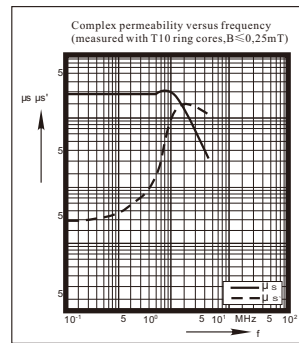

P3

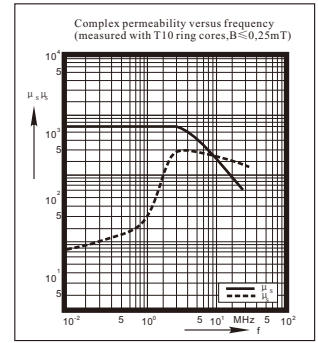

H5K

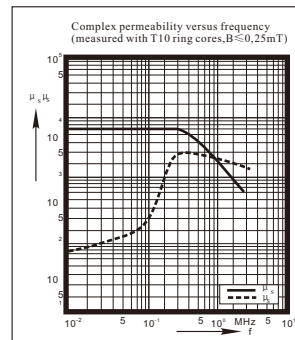

H7K

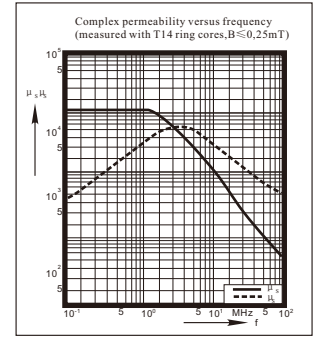

H10K