



**PAIRUI**

Http:fuantronics.com

**P3**    **T3.05\*1.27\*1.27**    **HP**  
**Material**    **Core Size**    **Coating**  
 材质    品名    涂装

HP:Parylene Coating of Ja;pgem-Free

**Dimensions: (UNIT:mm)**

Dimensions(mm)			
Parylene Coating Dimensions(mm)			
ΦD1	ΦD2	H	Wt(g/set)
3.05±0.25	1.27±0.15	1.27±0.15	0.04
3.05±0.25	1.27±0.15	1.27±0.15	

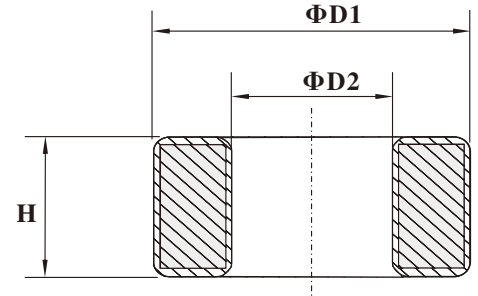
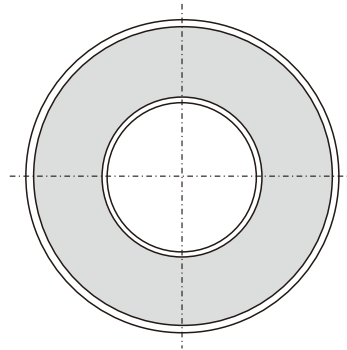

**Test Conditions**

AL: F=10.0KHz    U=0.3V    N=10Ts

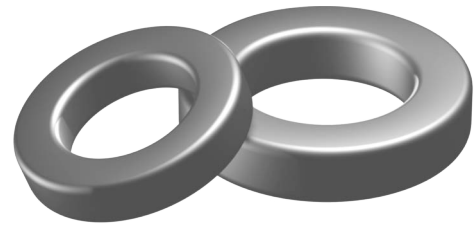

**Effective parameter**

	Ve(mm3)	Ae(mm2)	Le(mm)
	6.211	1.037	5.99

**Coating**

The core are coated with epoxy, flame retardant in accordance with "UL 94V-0" file number E228348. The colour is green.

**Ring core data**

GRADE	AL(nH)	μi	TYPE NUMBER
P3	570±25%	≈2300	T3.05/1.27/1.27/P3
H5K	1112±25%	≈5000	T3.05/1.27/1.27/H5K
H7K	1668±25%	≈7000	T3.05/1.27/1.27/H7K
H10K	2224±30%	≈10000	T3.05/1.27/1.27/H10K

**Note:**

- 1: Document is the property of FUAN Inc & is not allowed to be duplicated without authorization
- 2: RoHS compliant.

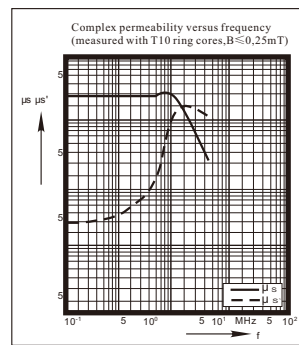

P3

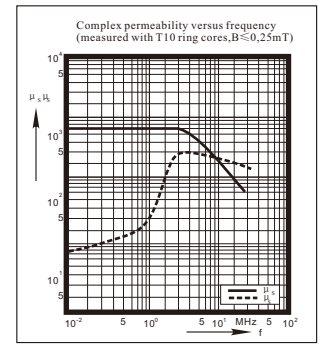

H5K

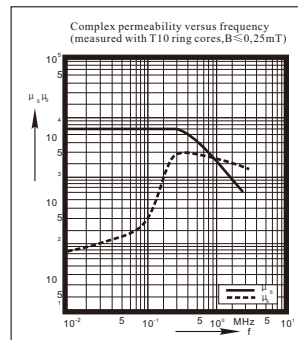

H7K

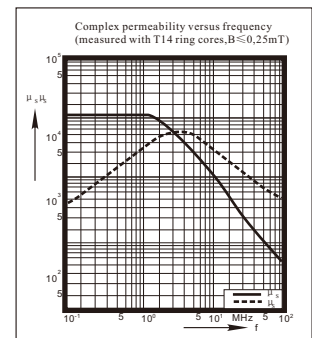

H10K